

## KIKK Teaching Guide Instruction Manual for Auto Tip Changer (TT-ATC-\*\*)

Please read this instruction manual carefully and use it correctly before using it.

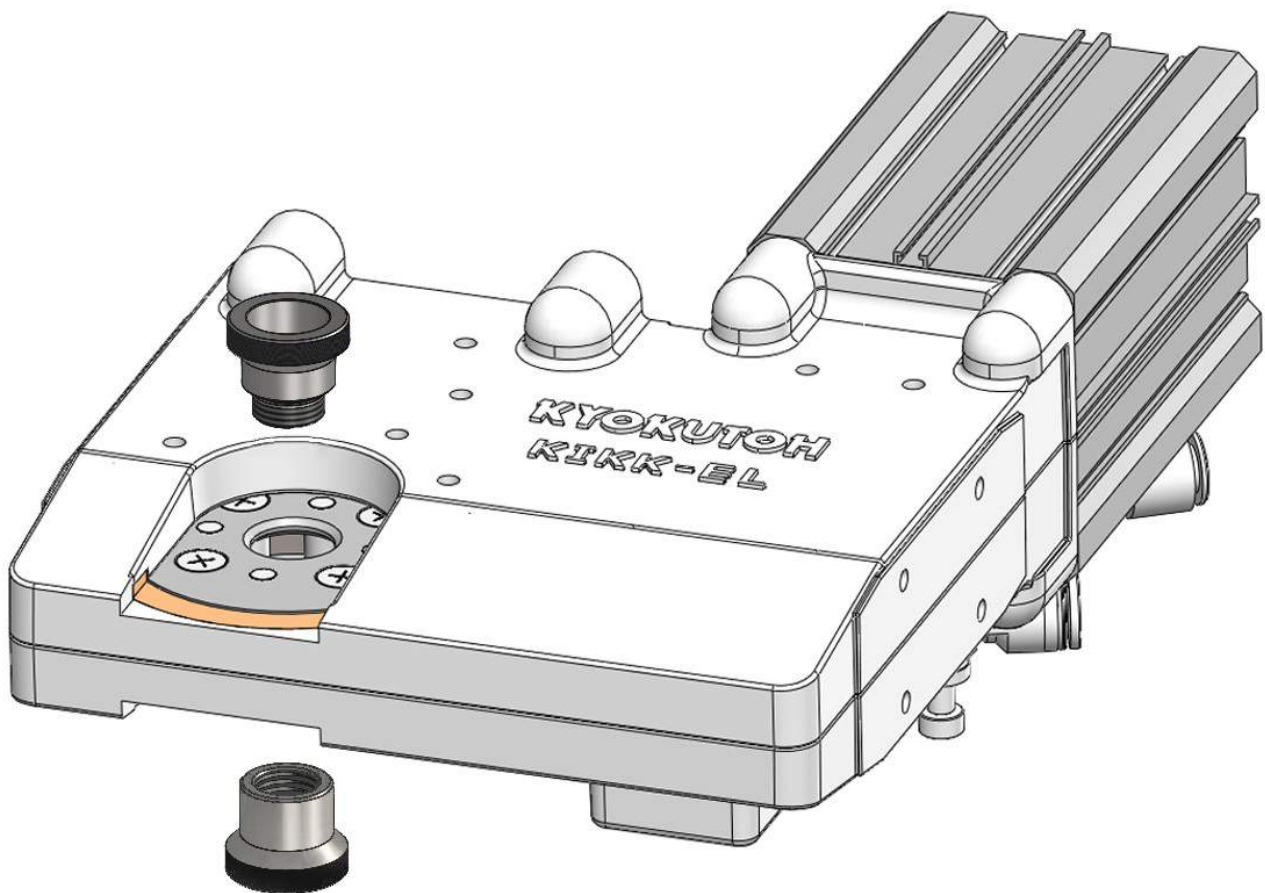

※KIKK is sold separately.

# Content

1. Precautions	_____	2
2. Suitability Mode	_____	3
3. How to use	_____	4
Contacts	_____	10

# 1. Precautions

**※This product is different from the suitable product by the shape of the cap tip.**

**If you work with a improper teaching guide,**

**It cannot be performed.**

**Please carry out the work after you check the suitability.**

## ■ Precautions

The teaching guide for KIKK auto tip changer is used to in our manufacturing tip changer, that it is easy to carry out teaching of robot gun.





This product reduces errors caused by teaching precision, and ensures proper performance of the remover and normal operation of the facility.

This product supports the teaching of the tip changer. It cannot be used for any other purpose. Also, it cannot be used for the tip changer other than the specified type.

①Use other than specified model ②Use other than correct purpose ③ Use other than correct purpose

We cannot hold responsible for any failures, repairs, accidents, or other errors that occurred in the event of carrying out above 3 items, so please understand it in advance.

## ■ Symbol

 Warning	Be careful to follow directions as specified, as an error could lead to possible injury or death.
 Caution	Be careful to follow direction as specified, as an error could lead to malfunction and serious damage.
	This symbol indicates operations that should not be done.
	This symbol indicates operation that should be done.

## ■ Usage Precautions



- Do not perform the remove operation during use of the teaching guide to prevent damage to the tip changer.
- Be sure to remove the teaching guide after confirming the middle of the gun and the tip changer.

If a re-remove operation is carried out with the teaching guide installed, there is a risk of damage to the tip changer.

## 2. Suitability Mode

### ■Line up

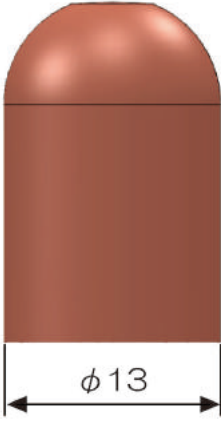
The matching list of this product is as follows:

TT-ATC-16	TT-ATC-13
 <p>A brown, dome-shaped cap with a diameter of 16mm. The diameter is indicated by a dimension line below the cap.</p>	 <p>A brown, dome-shaped cap with a diameter of 13mm. The diameter is indicated by a dimension line below the cap.</p>
TT-ATC-19	TT-ATC-20
 <p>A brown, dome-shaped cap with a diameter of 19mm. The diameter is indicated by a dimension line below the cap.</p>	 <p>A brown, dome-shaped cap with a diameter of 20mm. The diameter is indicated by a dimension line below the cap.</p>

## 3. How to use

### ■ Precautions before using

- Cap tip must be equipped with new products and operate.
- Check whether the robot is horizontal or vertical.
- Check the suitability for shape of cap tip and teaching guides.
- When operating a robot, make sure that there is no danger around it.

### <1. Upper Teaching>

#### ■ Work Order

1. Check if the tip changer groove is containment.

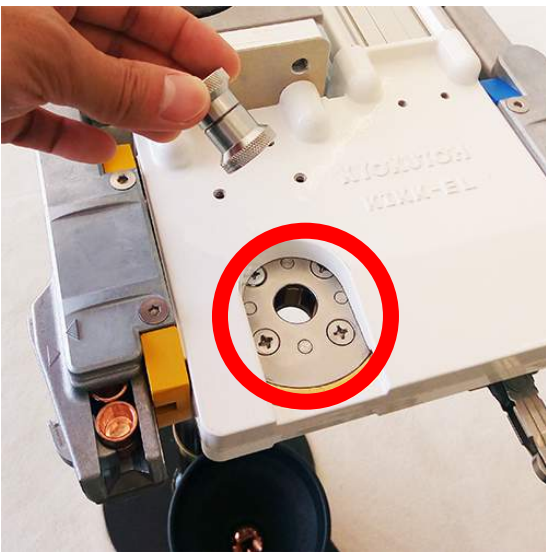

2. Install the teaching guide.

※Check if it is mounted slopingly.

※There is no upper or lower part of the product.

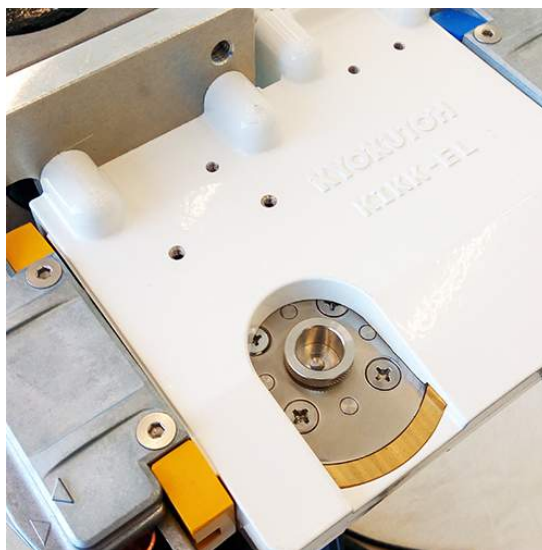
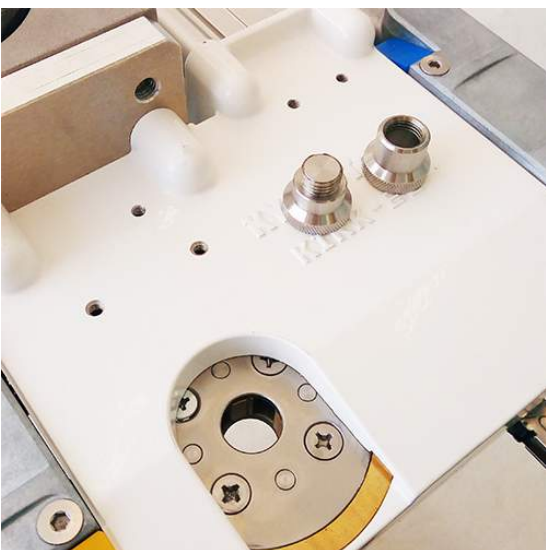

3. Close the gun to the teaching guide.

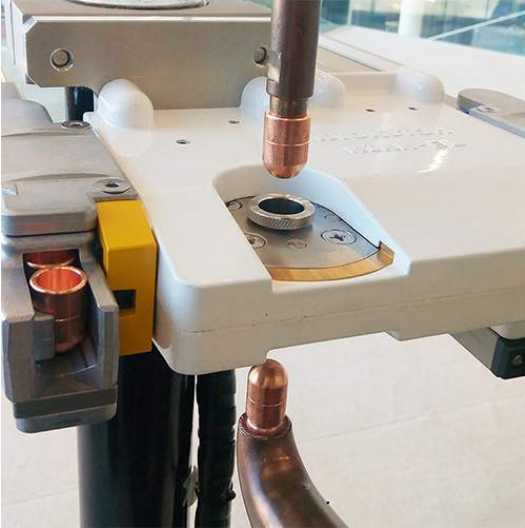

4. Adjust horizontal and vertical and move directly on the center of the teaching guide.

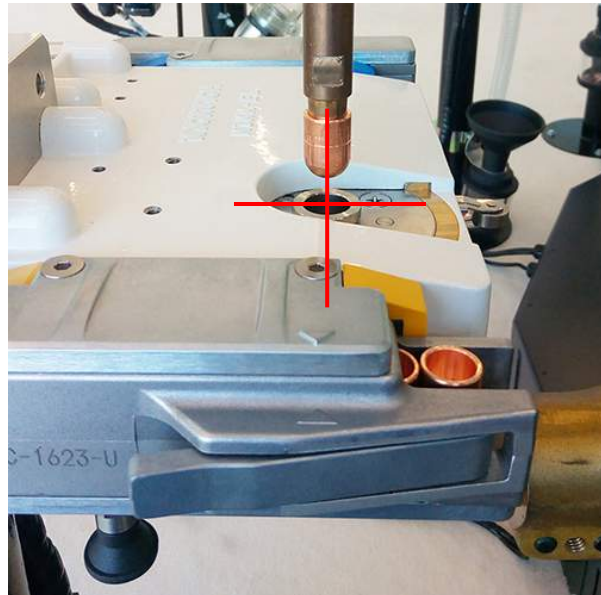
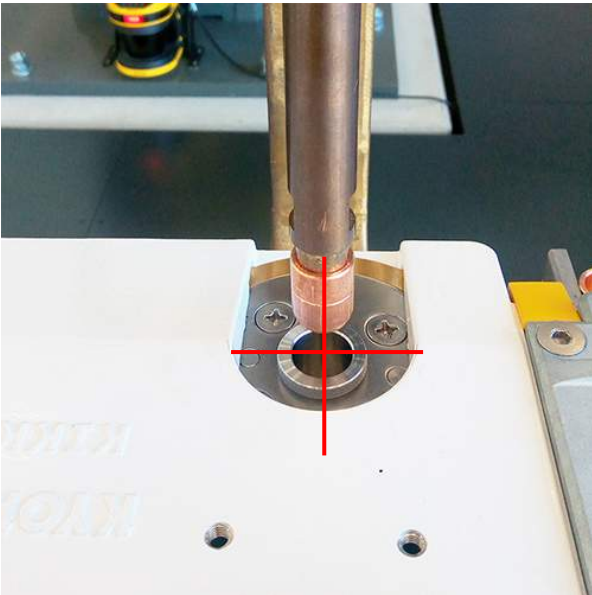

5. Finely adjust and insert the cap tip into the teaching guide about 10mm.  
If it is inserted correctly, horizontal and vertical are adjusted.

 Warning

Make sure that the cap tip do not reach to the bottom.

If it is continued to insert into the bottom, it may damage the product.

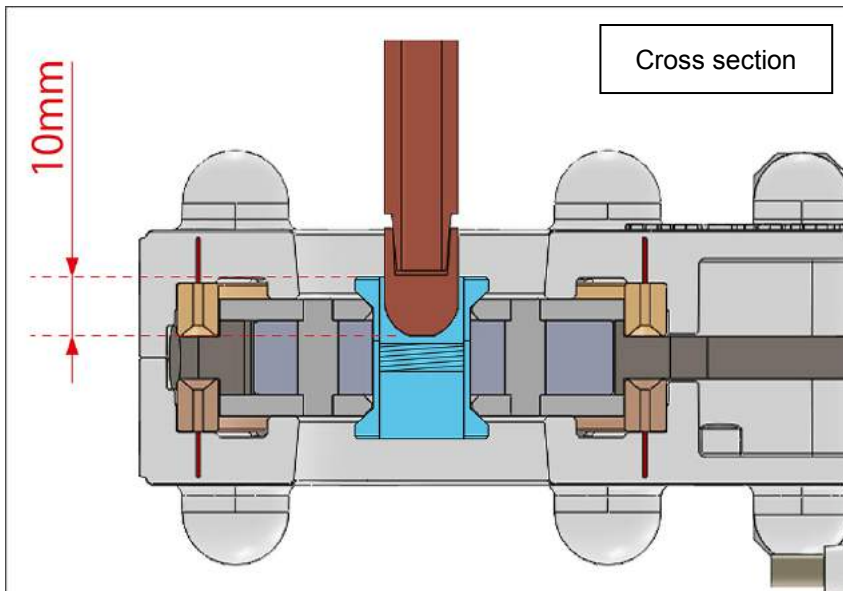
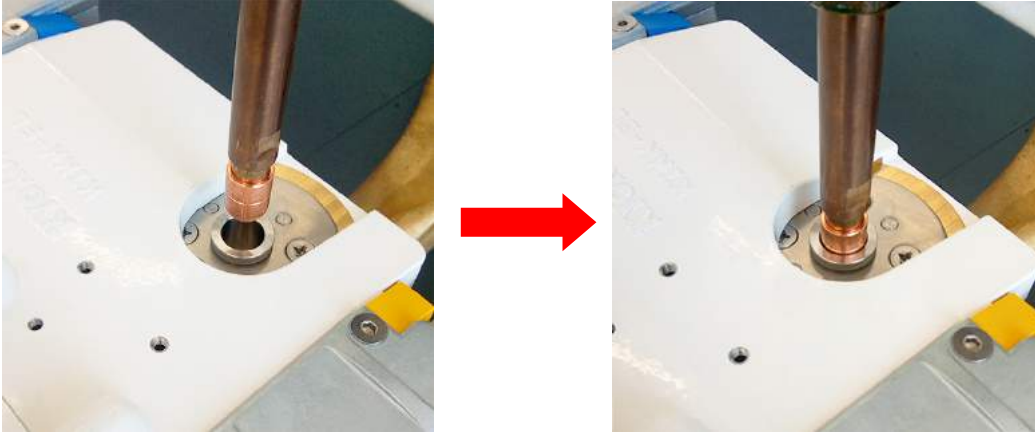

6. After inserting the cap tip into the center, and retreat it in the upward direction of the Z-direction.

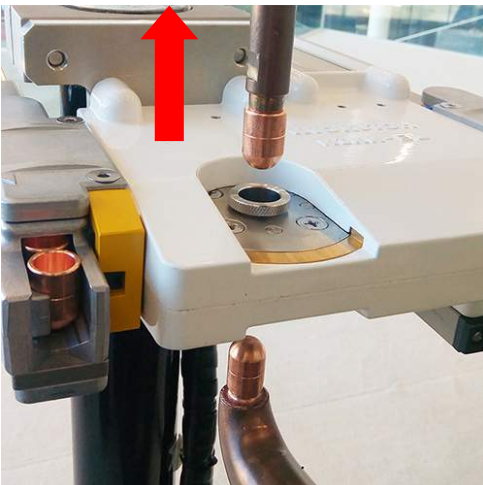

7. After retreating, remove the teaching guide.

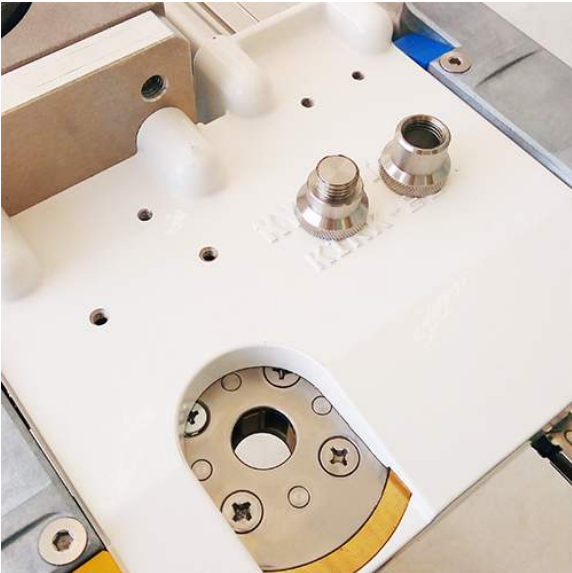

8. Insert the cap tip back into the center of the groove of remover, adjust the cap tip surface to parallel with the remover face

※Make sure that the two red sides of the picture on the right are parallel.

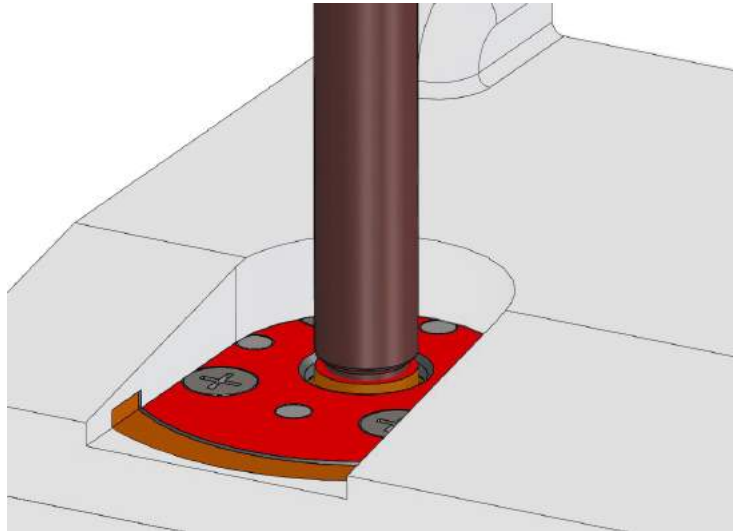

◆ As shown in the picture on the right above, the center of the cap tip and the groove are adjusted as the cross-sectional view, if adjust aligning the cap tip surface with the remover face.

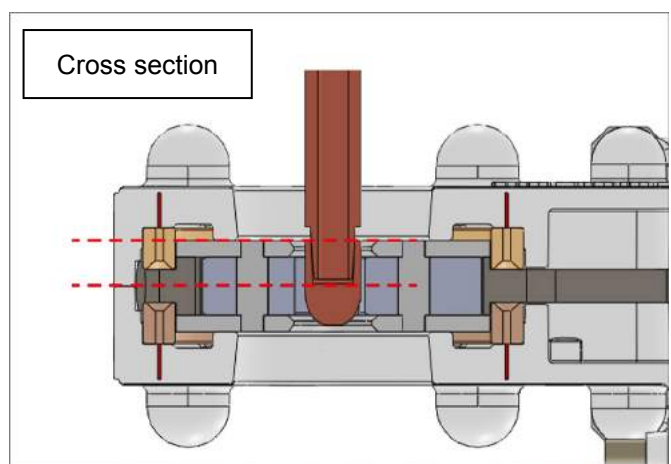

9. When adjustment is complete and position is registered, the top teaching is complete.



## <2. Bottom teaching>

### ■ Work order

1. After finishing the top teaching, retract the gun to work on the bottom.

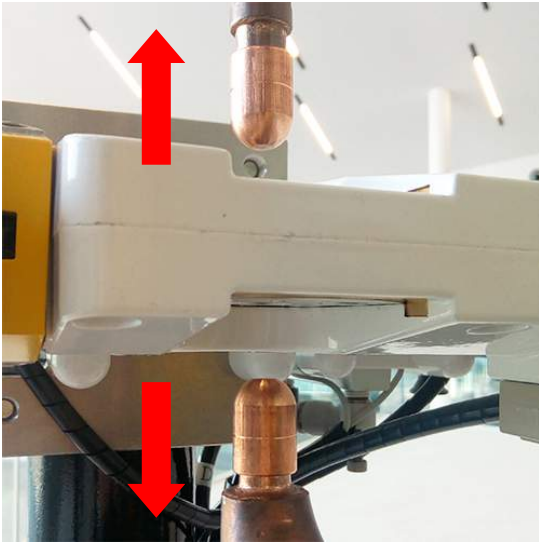

2. Check if the grooves are containment in the same way as above.



3. Install the teaching guide.

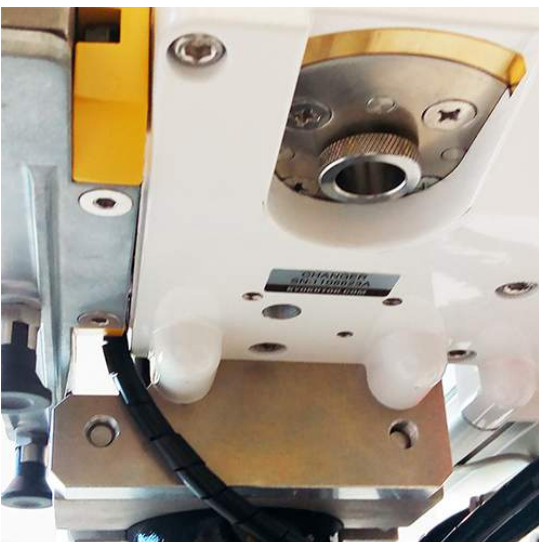

4. Finely adjust and insert the cap tip into the teaching guide about 10mm.  
If it is inserted correctly, horizontal and vertical are adjusted.



5. If it is inserted to the center, remove the teaching guide as above,  
Insert the cap tip again to parallel the surface of cap and remover.



6. When you register position, the bottom teaching is completed.

**Completed**

**※For teaching other than the remover section, please refer to the [teaching page] in the KIKK instruction manual.**

# Contacts

Contact us if there is any damage or machine defects in our products.



## **KYOKUTOH CO., LTD**

181-1, Nakayashiki, Orido-cho, Nisshin, Aichi 470-0115 Japan

TEL +81-561-72-8811 FAX +81-561-72-8821

E-Mail: [sales@kyokutoh.com](mailto:sales@kyokutoh.com)

<http://www.kyokutoh.com>

## **KANTO SALES OFFICE**

TEL +81-49-277-4324 FAX +81-49-277-4325

## **HIROSHIMA SALES OFFICE**

TEL +81-82-569-6227 FAX +81-82-569-6228

---



## **CHANGER & DRESSER CORPORATION**

1527 ITC Way, Anniston, AL 36207 U.S.A

TEL +1-256-832-4392 FAX +1-256-832-4393

<http://www.changer-dresser.com>

---



## **KYOKUTOH CHINA**

73 Huagang Street, Xiuquan Town, Huadu District,  
GuangZhou City, GuangDong Province, China.

TEL +86-20-86980880 FAX +86-20-86980890

<http://www.kyokutoh.com.cn>

---



## **KYOKUTOH THAILAND**

339/2 Soi Phattanakarn 69, Phattanakarn Road, Prawet,  
Bangkok 10250 THAILAND

TEL +66-272-162-82 FAX +66-272-162-84

---



## **KYOKUTOH KOREA**

117, Tawon TAKRA II Industry Center, Dongsan-ro 76,  
Danwon-gu, Ansan-si, Gyeonggi-do, Korea 15434

TEL +82-31-414-8730 FAX +82-31-414-8731

---



## **KYOKUTOH EUROPE**

Radlkoferstr. 2 81373 Muenchen, Germany

TEL +49-89-7411-85313 FAX +49-89-7411-85315

---